

For standby power supplies.
Expected trickle design life: 10 – 12 years at 20°C according to Eurobat.



Contents indicated (including the recycle marking, etc) are subject to change without notice.

Dimensions(mm)

Terminal type (option)

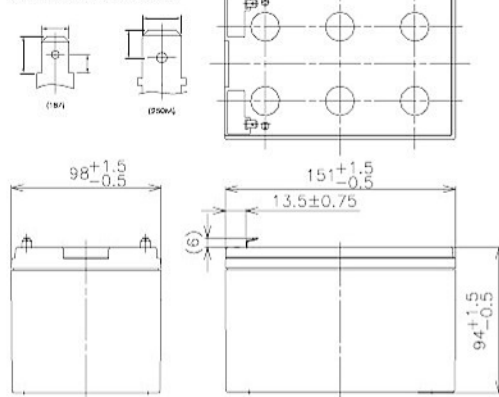

Battery case resin: Flame-retardant (UL94V-0)

Specifications

Nominal Voltage	12V	
Rated Capacity(20HR)	12Ah	
Dimensions	Length	151 mm
	Width	98 mm
	Height	94 mm
	Total height	100 mm
Approx. Mass	3.65 kg	
Terminal	Faston 187 & 250M	

Characteristics

Capacity (25 °C)	20 hour rate	12Ah
	10 hour rate	10Ah
	3 hour rate	9.3Ah
	1 hour rate	8.5Ah
Internal Resistance (25 °C)	Fully charged battery	18 m
Temperature Dependency of Capacity (20 hour rate)	40	102%
	25	100%
	0	85%
	-15	65%
Self Discharge (25 °C)	After 3 months	91%
	After 6 months	82%
	After 12 months	64%

Duration of discharge vs. discharge current

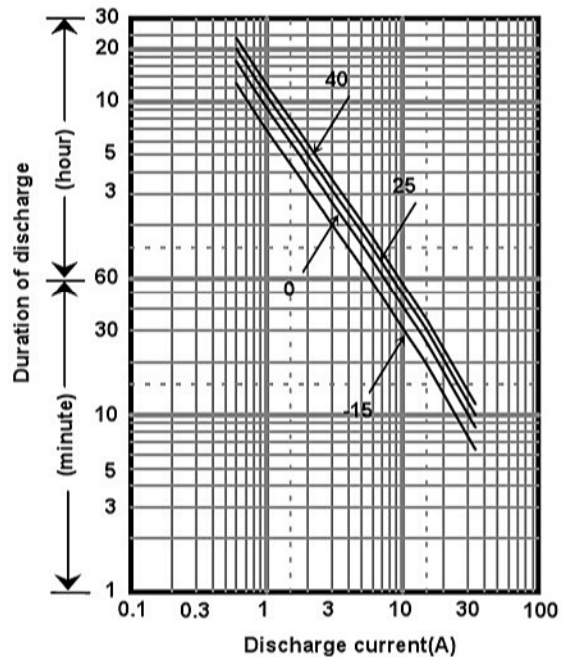

Watt Table(25 °C)

(Wattage/Battery)

Cut-off V	3min	5min	10min	15min	20min	30min	45min	1h	1.5h	2h	3h	4h	5h	6h	10h	20h
9.6V	679	559	384	298	247	183	137	105	70.3	54.5	38.1	28.8	24.1	21.7	13.3	7.22
9.9V	649	537	373	288	241	177	135	104	69.9	54.2	37.8	28.7	24.0	21.7	13.3	7.22
10.2V	607	506	363	282	235	175	134	102	69.1	53.9	37.5	28.6	23.9	21.6	13.2	7.21
10.5V	556	475	343	271	231	172	133	100	68.5	53.3	36.9	28.5	23.8	21.6	13.2	7.20
10.8V	495	434	321	261	225	166	123	97.8	66.1	52.1	36.3	28.4	23.7	21.5	13.1	7.18

Ampere Table(25 °C)

(Ampere/Battery)

Cut-off V	3min	5min	10min	15min	20min	30min	45min	1h	1.5h	2h	3h	4h	5h	6h	10h	20h
9.6V	61.1	50.1	34.3	25.9	21.3	15.6	11.7	8.90	5.95	4.60	3.20	2.41	2.01	1.81	1.11	0.602
9.9V	58.4	48.2	33.3	25.0	20.8	15.1	11.5	8.80	5.92	4.58	3.18	2.40	2.01	1.81	1.11	0.602
10.2V	54.6	45.4	32.4	24.5	20.3	14.9	11.4	8.70	5.85	4.55	3.15	2.39	2.00	1.80	1.10	0.601
10.5V	50.0	42.6	30.6	23.6	19.9	14.7	11.3	8.50	5.80	4.50	3.10	2.38	2.00	1.80	1.10	0.600
10.8V	44.5	38.9	28.7	22.7	19.4	14.2	10.5	8.30	5.60	4.40	3.05	2.37	1.99	1.79	1.09	0.598

All mentioned values are average values

Charging Method (25)

Trickle use	Control voltage: 13.6-13.8V Initial current: 1.80A or smaller
-------------	------------------------------------------------------------------

Cut off voltage

Discharge current	0.600A-2.40A	2.40A-6.00A	6.00A-12.0A	12.0A-24.0A	24.0A-36.0A
Cut off voltage(V)	10.5	10.2	9.9	9.3	8.7

Influence of Temperature on Trickle life

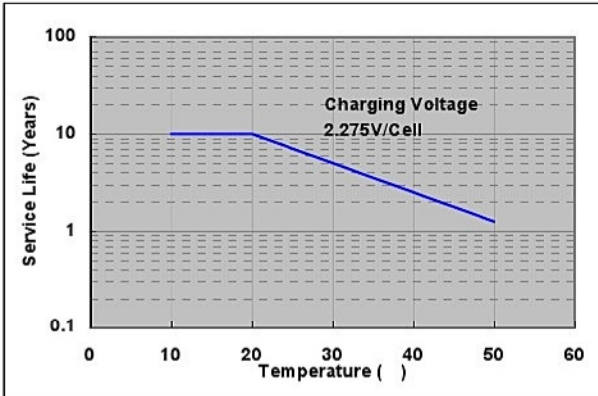

Residual capacity test result

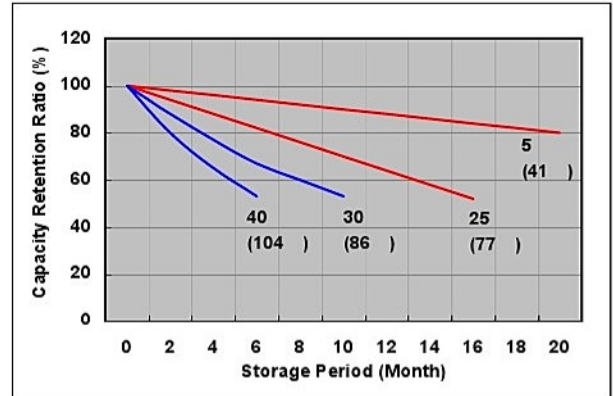

Constant-voltage constant-current charge characteristics for Trickle use

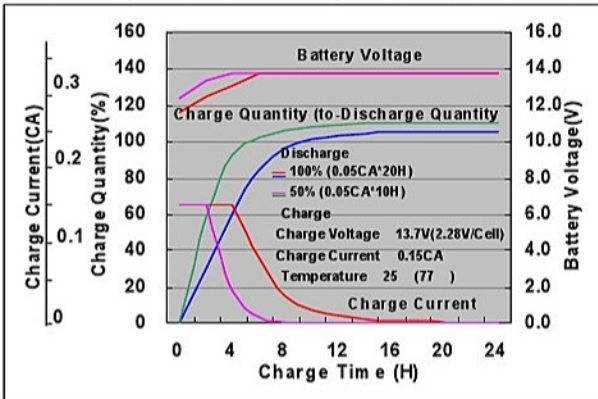

Discharge capacity by temperature and by discharge current

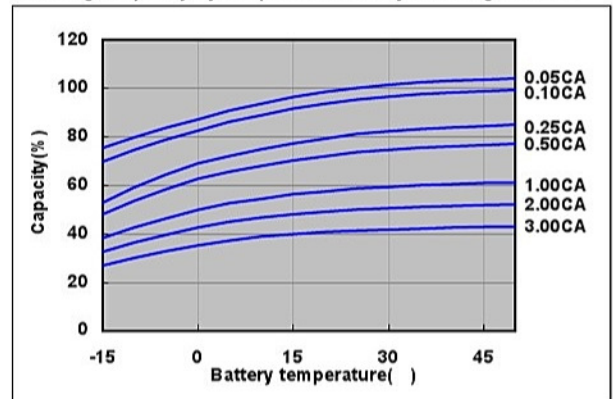

Discharge characteristics(25)

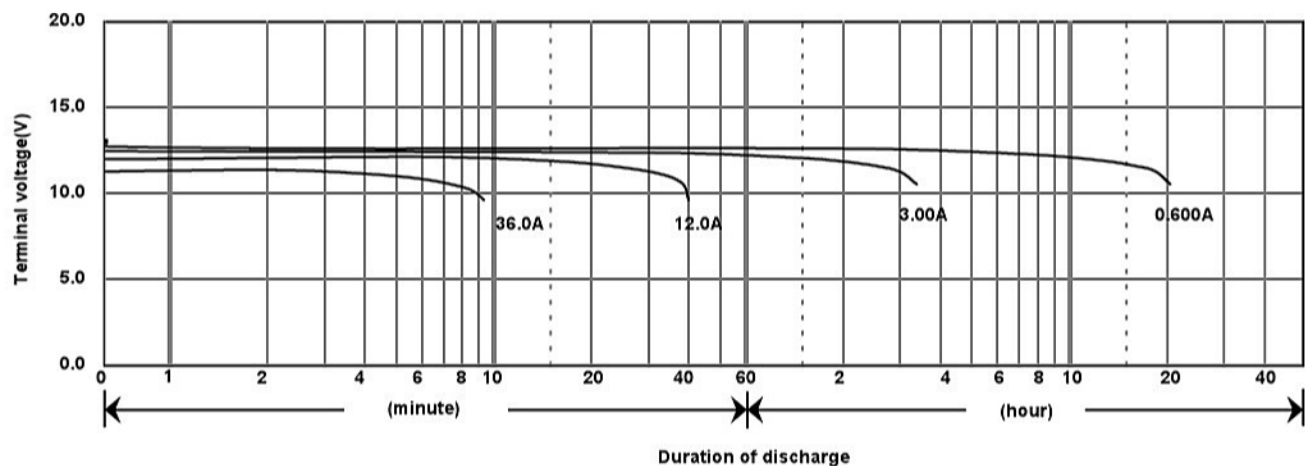

⚠ Caution

Due to the potential energy stored in the batteries, Please read Precautions for handling the Rechargeable Valve Regulated Lead Acid Batteries before using batteries. If improper handling or use of the batteries without understanding Precautions for handling the Rechargeable Valve Regulated Lead Acid Batteries may result in bodily injury caused by electrolyte leakage, heat generation, or explosion.